

HYUNDAI
POWER PRODUCTS

PETROL LAWN MOWER

HTDT561ES-1

ORIGINAL INSTRUCTIONS

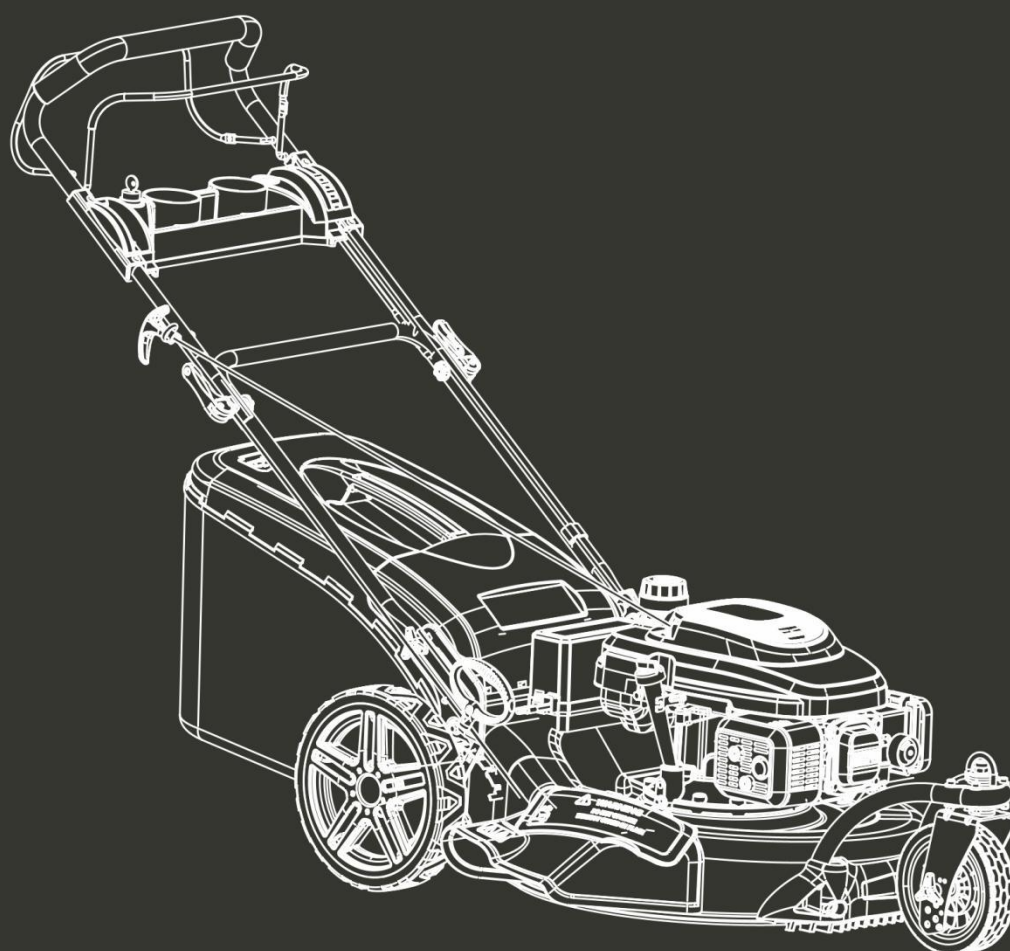

WARNING: Read thoroughly the instruction manual before using.

CONTENTS

1. SAFETY INSTRUCTIONS.....	3
2. YOUR PRODUCT.....	7
3. ASSEMBLY.....	10
4. OIL AND FUEL FILLING.....	12
5. USE.....	13
6. MAINTENANCE.....	14
7. STORAGE.....	16
8. PROTECTION OF THE ENVIRONMENT.....	16
9. TROUBLESHOOTING.....	17
10. DECLARATION OF CONFORMITY.....	18
11. WARRANTY.....	19
12. PRODUCT FAILURE.....	20
13. WARRANTY EXCLUSIONS.....	21

1. SAFETY INSTRUCTIONS

Instructions

- Read the instructions carefully. Be familiar with the controls and proper use of the equipment.
- Never allow children to use this mower. If the mower is given to another person, also give this manual. Also make sure that this person uses this device only after receiving the necessary instructions. Local laws may restrict the age of the user.
- Never mow while people, especially children, or animals are nearby.
- Keep in mind that the operator or user is responsible for accidents or risks that may occur to other persons or their properties.
- If necessary, have training with an experienced person in order to use in a safe way this tool.

Preparation

- During mowing, always wear slip-resistant foot protection and long pants. Do not use the equipment barefoot or wearing sandals open.
- Wear personal protective equipment including at least: clothes of protection, gloves, foot protection, mask, ocular and hearing protection
- Carefully inspect the area where equipment and remove all foreign objects such as stones, toys, stick and wires.
- **WARNING** - Gasoline is extremely flammable.
 - Add fuel before starting. Do not remove the fuel tank cap while the machine is running or when it is hot.
 - If the fuel has spilled or leaked, do not attempt to start the machine but move the machine away from the leakage area and avoid creating a source of ignition until the gasoline vapours has dissipated.
 - Refuel only outside and do not smoke during refuelling.
 - Store fuel in tanks specifically designated for this purpose.
 - Replace the fuel tank or the defective gasoline plug securely.
- Replace defective mufflers.
- Before use, always inspect visually that the blades, blade assembly and blade lock are not worn or damaged. Replace blades and blade assemblies that are not in good condition to maintain balance. Always use recommended blades. Contact the manufacturer or your dealer in order to have a list of recommended blades. Non recommended blades can give a risk of malfunctions, injuries and accidents.
- The blades must be balanced to ensure proper operation and to be able to work safely.

Operation

- Do not use the machine in a confined space or hazardous carbon monoxide emissions can be collected.
- Mow only under daylight or under good artificial light. Always have a good visibility.
- Avoid using the equipment on greasy grass, where possible.
- Always be sure of your walking on the slopes.
- Walk, never run.
- For lawn mowers, mow across slopes, never from top to bottom.
- Exercise extreme caution when changing direction on slopes.
- Stop the blades if the mower is to be tilted during transport when crossing surfaces other than grass, and when transporting the mower due to the area to be mowed.
- Do not mow on steep slopes.
- Use extreme caution when tipping or pulling the mower towards you.
- Never use the mower with defective guards, or without safety devices such as baffles and or

collection bins, which are not in place.

- Do not change the motor configuration or increase the speed.
- For starting, disengage all blades, the gears must be in neutral, the traction control lever must be released. Set foot well away from the blades.
- Before starting the engine or starting the engine, carefully read and understand all instructions.
- Do not tilt the mower when starting the machine or turn on the engine, unless the mower needs to be tilted for starting. In this case, do not tilt it more than absolutely necessary and lift only the part that is furthest away from the user.
- Do not start the machine by standing in front of the ejection
- Do not place hands or feet near or under rotating parts. Keep clean the mouth of the grass extractor.
- Never take or carry the mower while the machine is running.
- Stop the machine and remove the ignition key, disconnect the spark plug from the spark plug:
 - Before cleaning or unclogging the grass extractor.
 - Before checking, cleaning, and working on the mower.
 - After hitting an object. Inspect the mower for damage and repair before re-using the mower.
 - If the mower begins to vibrate abnormally, stop the engine immediately and check according to previous recommendations.
- The controls must be always checked if they are functioning correctly. In case of malfunction, do not use the tool and bring to a service agent for inspection.
- Stop the engine immediately:
 - Every time you leave the tool alone and the working area
 - Before refuelling.
- When the tool is stopped, park it in a safe place.
- Move slowly when moving.
- The lawnmower should not be used in slopes and near drop-offs, ditches or embankments; if the tool must be used in these kinds of emplacements, take an extreme precaution and operate carefully the tool.
- The lawnmower safety systems or features shall not be tampered with or disabled;
- The operator should not alter or tamper with any sealed adjustments for the engine speed control.

Maintenance and storage

- Check and tighten all bolts and screws to ensure that the equipment is in safe operating condition.
- Never keep the mower with gasoline in the tank in a building or vapours can cause a bright flame or spark.
- Allow the machine to cool before storing it in an enclosed area.
- To reduce the risk of fire, keep the machine clean without grass, without grease, the muffler and the engine cools, disconnect the battery if necessary and empty the fuel tank
- Check the grass catcher frequently, its condition or deterioration.
- Replace worn and damaged parts for safety.
- If the fuel tank is to be drained, it must be made outdoors.

Special safety instructions

- Always use the mower with its pick-up bag and / or deflector in the intended position.
- Switch off the engine before emptying the pick-up bag or before changing the cutting height.
- While the engine is running, never put your hands or feet under the mower or under the grass ejection area.
- Before mowing, remove all foreign objects from the grass that can be propelled by the machine.

- Keep children and pets at a safe distance while using the mower.
- Never lift the mower when the engine starts.
- Alcohol, drug, as well as illness, fever and fatigue affect your ability to respond. Do not use power tools in such circumstances.
- Never change the rated speed of the motor.
- Never lift or carry the tool while the engine is running.
- Before starting the engine, release the drawbar.
- Before mowing, install the collection bag in its intended position.
- Do not use the mower in the event of rain or when the grass is wet.
- Never lift the rear of the mower when starting the engine and never place your hands or feet under the mower deck or in the rear ejection port while the engine is running.
- Turn off the engine and remove the spark plug cap in the following cases:
 - Before operating under the mower deck or near the ejection opening.
 - Before any maintenance, repair or verification.
 - Before transporting, lifting or storing the mower.
 - If you leave the mower unattended or change the cutting height.
 - To remove and empty the collection bag.
- After striking a foreign object, turn off the engine and carefully inspect the mower for damage. Take the lawnmower to an authorized service center for repair if necessary.
- If the mower vibrates abnormally, try to understand the reason and bring your lawnmower to an authorized repair center.
- Regularly check that the bolts, nuts and screws are properly tightened for safe use of the mower.
- Do not use the tool where there is a risk of lighting.
- Use the tool on daylight or under a good lighting. Always keep bystanders away.
- Warning: Take an extreme precaution when operating the lawnmower in slopes and near drop-offs, ditches or embankments; always be sure of your footing and stay in alert.
- the lawnmower safety systems or features shall not be tampered with or disabled;
- the operator should not alter or tamper with any sealed adjustments for the engine speed control;
- The operator must have, before using the tool for the first time, an adequate training with an experienced people.
- Warning: do not use of the unit while being tired, ill or under influence of alcohol or other drugs;
- Park safely the tool before leave it. The tool must be switched off.
- The lawnmower shall not be operated without either the entire grass catcher or self-closing discharge opening guard in place;
- Warning: be careful about exhaust gas. Do not inhale them.
- Wear adequate clothing such as long trousers and a protective equipment: slip-resistant foot protection, hearing protection, eyes protection and gloves.
- To avoid health issues, limit the time of operation. Take enough rest. Exposure to noise and vibrate can have bas consequences on health.
- WARNING: There is a danger about moving blade assemblies. Always handle blades when they are in a complete stop and wear protective gloves.
- WARNING: There is a danger about moving blade assemblies. Always handle blades when they are in a complete stop and wear protective gloves.

Fuel Handling

Use caution when handling fuels. They are flammable and the vapours are explosive.

Use only an approved container.

Never remove the fuel cap or add fuel while the machine is on. Turn off the unit and allow the engine and exhaust components to cool down before refuelling.

Do not smoke.

Never refuel inside a room.

Never store the tool and the fuel tank indoors where there is a naked flame, such as near a water heater.

If fuel has spilled, do not attempt to start the machine, but move it away from the spill before starting to use it. Please clean up any spills.

Replace and tighten the fuel tank cap after refuelling.

Follow strictly the instructions in this manual for filling the tool with fuel.

During maintenance and storage

Switch off the tool and wait until it stops completely. Make sure that all moving parts are stopped.

Allow the machine to cool before performing inspection, adjustments, maintenance, servicing and storage.

Store the tool where fuel vapour will not reach a flame or spark.

The transport of the tool must be secured in order to avoid fuel spillage, accidents and injuries.

Residual risks

Even if you use this product in compliance with all safety requirements, the potential risks of injury and damage remain. The following hazards may arise in the structure and design of this product:

There are risks of injury and property damage due to attachments or broken the sudden impact of hidden objects when using cutting.

There are risks of injuries and accidents caused by flying objects.

Prolonged use of this product exposes the operator to vibrations and can produce so-called "white finger" disease. To reduce the risk, wear gloves and keep your hands warm.

If any of the symptoms of "white finger syndrome" occur, seek immediate medical attention.

Symptoms of "white finger" include numbness, loss of sensitivity, tingling, pain, loss of strength, colour changes or skin condition. These symptoms usually appear on the fingers, hands or wrists.

Risk increases at low temperatures.







A long exposition to noise can affect the health of the operator. A hearing protection must be always used when operating the tool. The operation of the tool must be limited and some rest must be taken between two sessions (e.g. 10min of operation and 20min of rest).



Intended use

This model of thermal mower is designed for natural grass mowing. Any other use is prohibited.

It is suitable only for private use in a garden or plot. Lawnmowers designed for private plots or gardens are those used for the maintenance of grassy areas and private lawns and should not be used in public areas, parks, sports, agricultural or forest areas.

Symbols

	Warning
	Read the instruction manual
 	Warning! Risk of projections. Keep bystanders away
  	Risk of injury from sharp blades! Keep your feet and hands away.

	<p>Stop the machine before removing any foreign objects from the working area. Never mow while people, especially children, or animals are nearby.</p>
	<p>Guaranteed sound power level</p>

2. YOUR PRODUCT

1. Description (figure **A**)

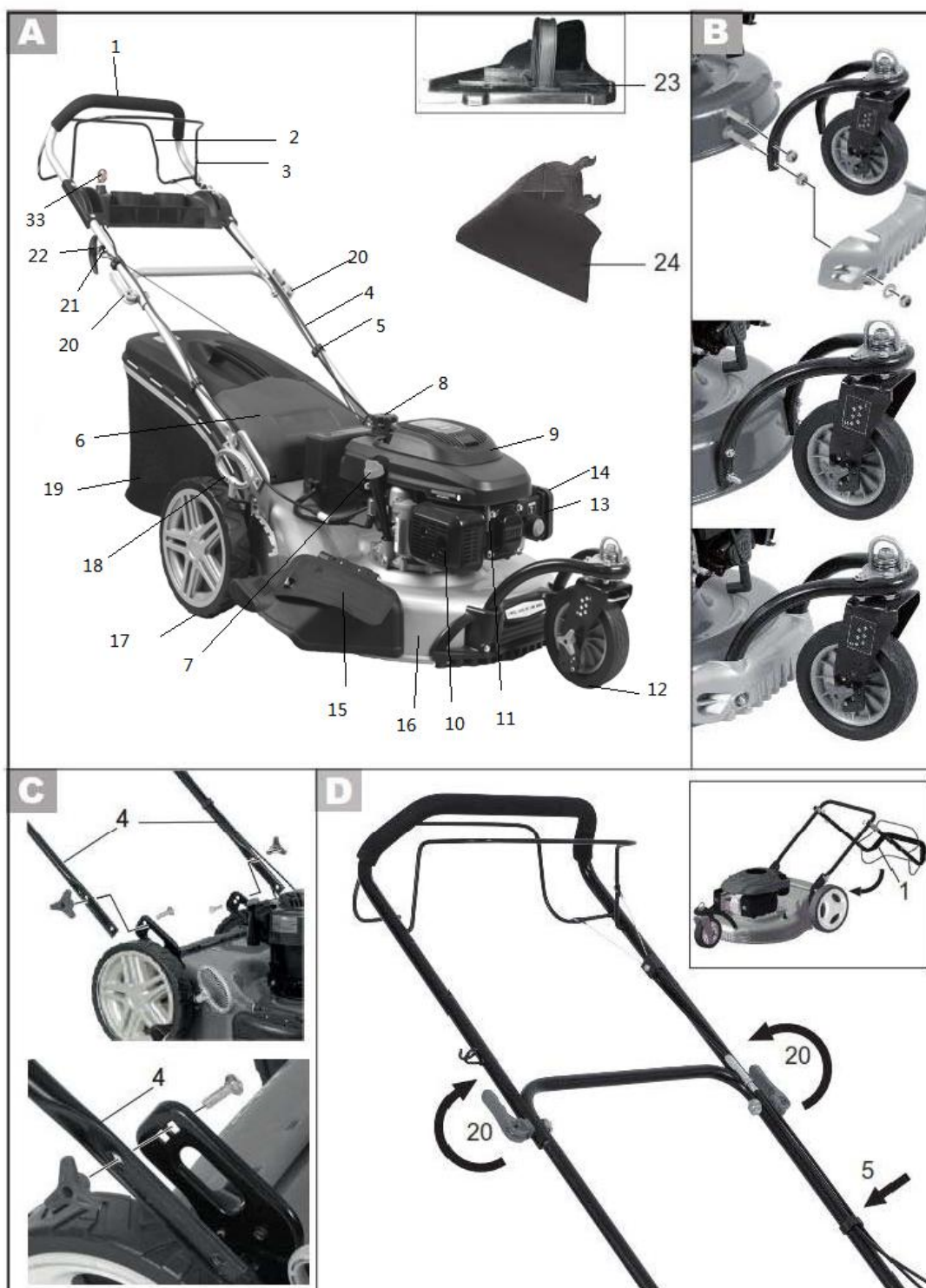

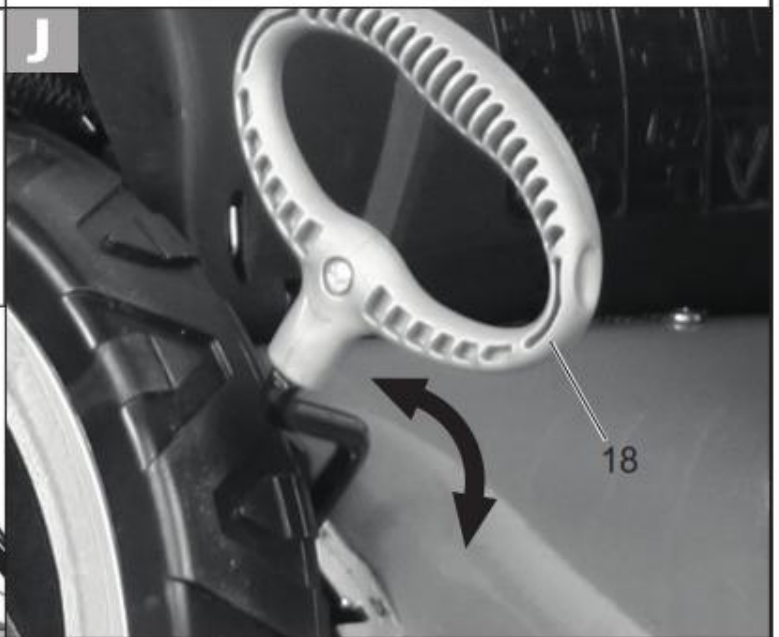
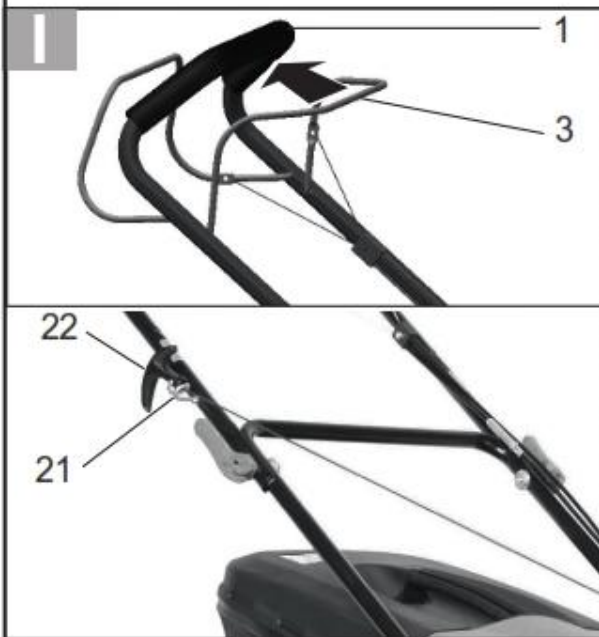
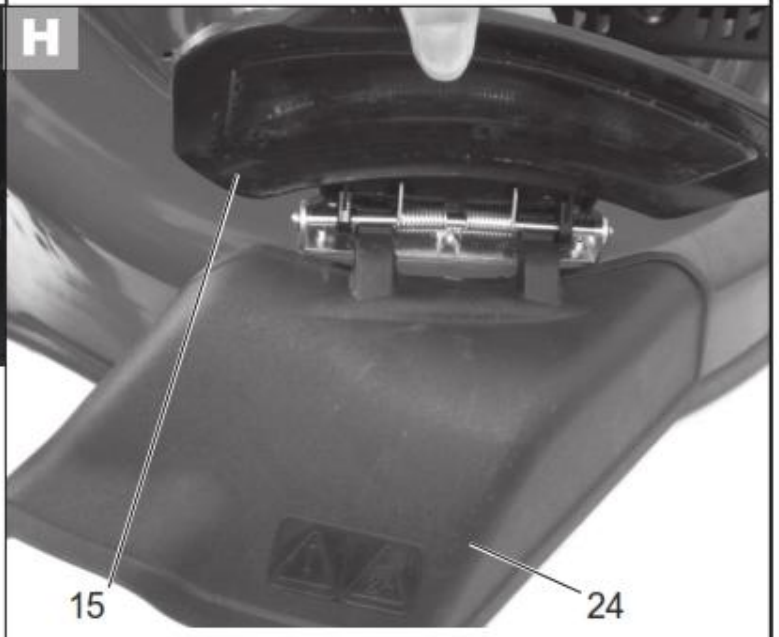
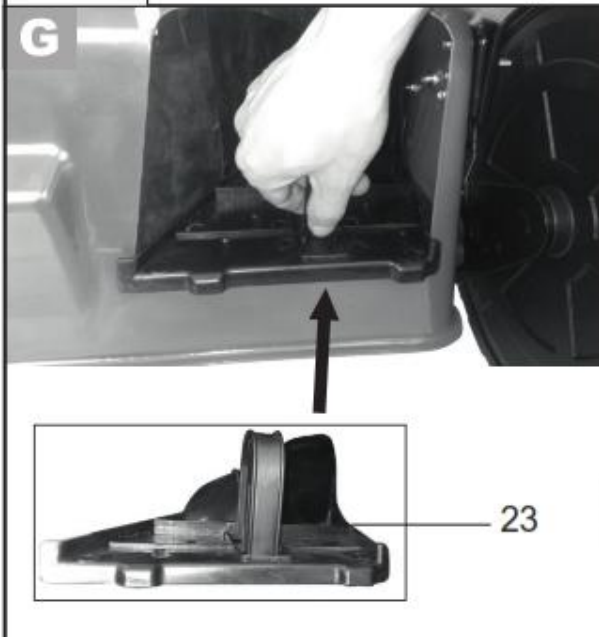
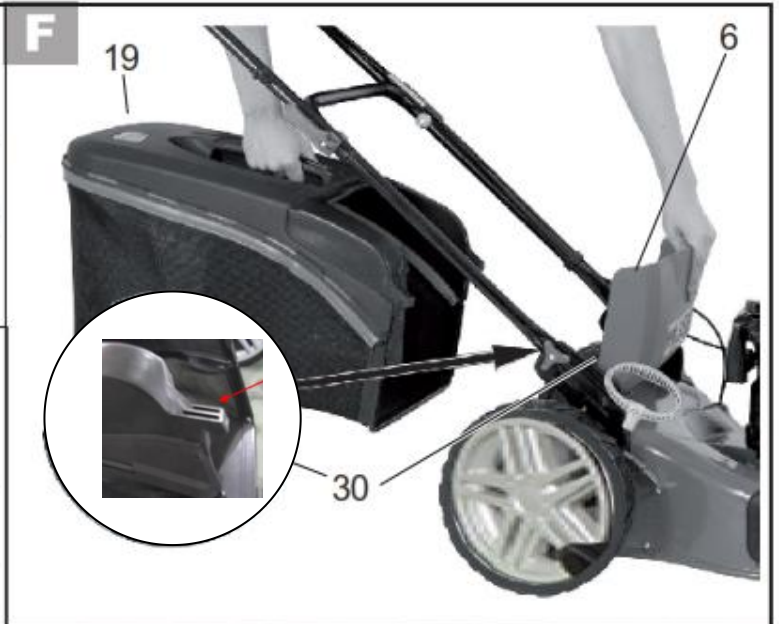

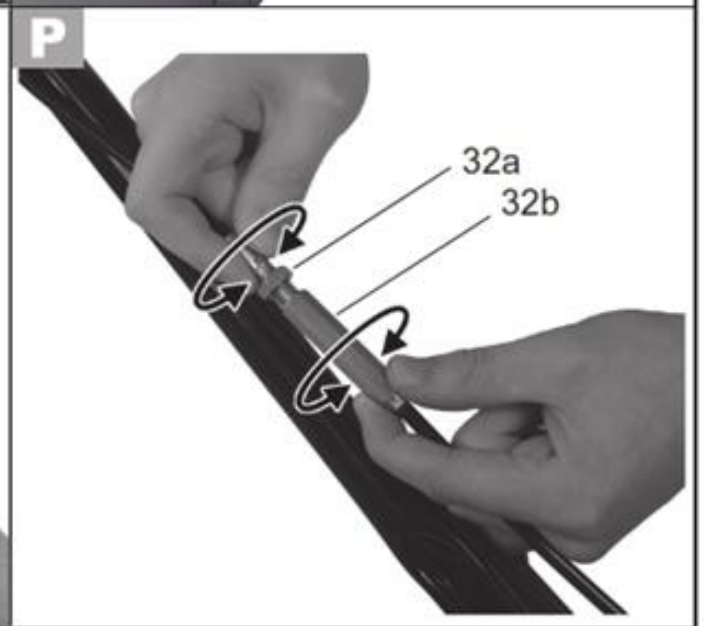
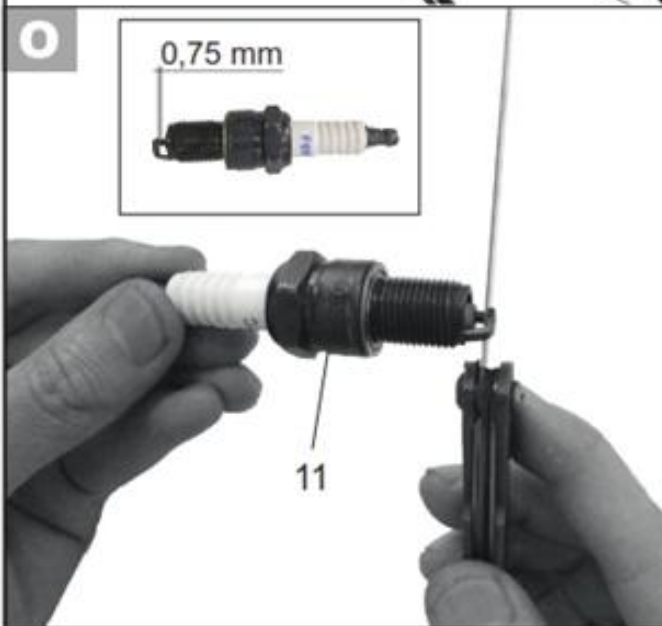
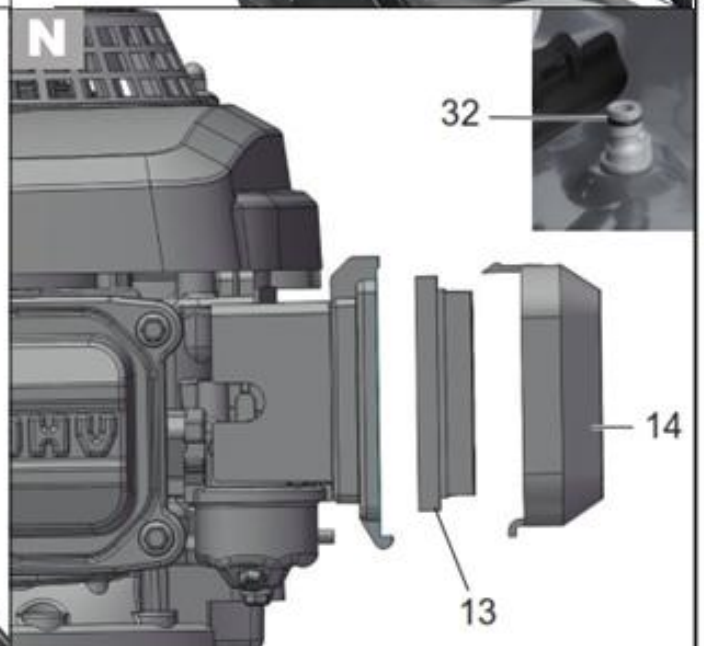

1	Upper handlebar	10	Muffler protection	19	Grass catcher
2	Training bar	11	Candle + candle sheet	20	Quick release levers for fixing the handlebars
3	Security bar	12	Front wheel	21	Hook
4	Lower handlebars	13	Air filter (not visible)	22	Starter cord
5	Cable clamp	14	Air filter cover	23	Mulching kit
6	Flap	15	Side discharge with flap	24	Side discharge duct
7	Oil tank cap with dipstick	16	Housing	33	Start key
8	Tank cap	17	Rear wheels		
9	Engine cover	18	Cutting height adjustment lever		

2. Technical specification

Power	3.5 kW
Engine	XP200
Engine displacement	196 cm ³
Maximum operating engine speed (rotational frequency)	2900/min
Torque clamping of the blades	45 Nm
Fuel tank volume	1,0 l
octane	95-98
Oil tank volume	600 ml
Engine oil	HD SAE 30 or 10W-30
Spark plug	Torch F6RTC or LG F6RTC
Cutting width	56 cm
Cutting height	6 positions 25-75 mm
Grass catcher volume	75 l
Weight	38,4 kg
Sound pressure level (L _{pA})	85,4 dB (A); K =3 dB(A)
Sound power level (L _{wA})	91,86 dB (A); K =4,53 dB(A)
Guarantee sound power level (L _{wA})	98 dB(A)
Vibration value	a _{hv} =6,211 m/s ² ; K=1,5 m/s ²

3. ASSEMBLY

NOTE: The blade is delivered already assembled. This part cannot be altered or changed by operator. In case that the blade needs to be replaced or sharpened, it shall be done by a specialist.

a. Front wheel (figure **B**)

- Insert the shortest screws through the upper holes of the tool. Fix them with the nuts.
- Install the decorative plate; make sure that the holes of the decorative plate are aligned with the lower holes of the tool.
- Insert the screws and then fix them with the nuts.

b. Front wheel height adjustment

Follow below pictures to adjust the height of the front wheel.



1

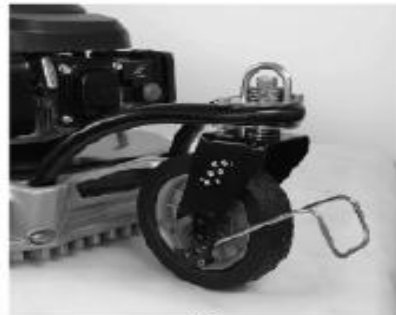

2



3



4



5



6



c. Bars assembly (figure **C and **D**)**

- Fasten the lower handlebar (4) with the fixing screws of the latter and with the wing nuts. To determine the desired inclination, choose one of the two possible screw positions.
- Fold down the upper handlebar (1) (small image) and press the lock lever (20) in the direction of the bar.
- Secure the control cables to the handlebars with cable clamps (5).

d. Grass catcher (figure **E and **F**)**

- Place the synthetic tabs (28) on the grass catcher (27).
- Lift the flap. Insert the handle into the grass catcher. The hook must be on the bar of the grass catcher emplacement.

NOTE: When using the grass catcher, do not use the mulching device and the lateral discharge in same time. These two functions must be removed first.

Disassemble the grass catcher

- Lift the flap and remove the grass catcher.
- Empty the grass catcher (see chapter 'Disposal / protection of the environment') and put it back in place.

e. Mulching kit (Figure **G)**

Before using the mulching kit, the side discharge duct must be removed

- Lift the flap.
- Remove the grass catcher, if fitted.
- Lift the flap (6).
- Insert the mulching kit (23).

Remove the mulching kit

- Lift the flap (6).
- Remove the mulching kit (23).

f. Lateral discharge duct

Before using the side grass discharge, the grass collection basket removed.

- Push on the left the unlock device.
- Lift the lateral flap.
- Hook the side discharge duct and lower the lateral flap.



g. Adjust the cutting height (Figure **J and **K**)**

The device has 6 positions for adjusting the cutting height (from 25 to 75 mm):

- Pull the lever (18) outward and push it to the desired position.
- Press the lever inward again.
- Set the corresponding height also on the front wheel. The label on the wheel mounting shows which height of the machine is set. Loosen the wing nut and secure the wheel to the desired position.
- Tightening the clamp locks the wheel in position. If the wheel rotates in the opposite direction, lift the clamp to remove the immobilizer. Bring the wheel to its new position and re-engage the clamp.



4. OIL AND FUEL FILLING

a. Oil filling

- Unscrew the oil tank cap with dipstick and pour oil into the tank. The oil tank has a capacity of 600 ml. Use a brand name oil (SAE 30 for example).
- To check the oil level, wipe the dipstick with a clean cloth and put it back into the tank.
- Read the oil level on the dipstick after pulling it out. The oil level must be between the two minimum and maximum marks.
- Wipe off any drops of oil you have dropped and close the oil tank cap
- Check the oil level each time before mowing and readjust when it is below the bottom mark.



b. Fill the fuel tank

Caution! Gasoline is flammable and toxic:

- keep the gasoline in suitable containers;
 - refuel only in the open air and never when the engine is running or the machine is hot;
 - open the tank cap carefully so that no overpressure can develop;
 - do not smoke when refuelling;
 - avoid contact with the skin and inhalation of vapours;
 - Clean the gasoline if you have spilled.
 - Keep gasoline away from any spark, flame or other source of fire.
 - Do not use gasoline and oil mixture.
 - Use normal or super unleaded gasoline.
 - Use only fresh and clean gasoline.
 - Do not store gasoline for more than a month as its quality may be reduced.
1. Unscrew the tank lid and pour gasoline to the lower edge of the filler cap. Do not fill the tank flush so gasoline has room to expand.
 2. Wipe the remaining gasoline around the tank cap and screw it back in.

5. USE

Start the device on a safe and flat ground, preferably not in tall grass. Make sure that the cutting tools do not touch objects or the ground.

a. Start the engine (figure I and L)

This lawnmower can be started electrically or manually

Electrically

1. Press the priming button 3 times (red button)



2. Pull the safety bar (3) towards you and hold it.
3. Turn the key (33). The engine starts.

Manually

Take the starter rope with your right hand and pull slowly as far as to have a resistance, and then pull energetically on the starter rope. (If the cold start is not sufficient enough, repeat this operation 2 or 3 times).

b. Stop the engine

Release the safety lever (3). The engine turns off and the blade is slowed down.

Regularly check the blade stopper:

Release the safety bar (3). The engine turns off and the blade is slowed down. The blade should stop after 3 seconds.

c. Mowing

- Self-propeller function (Figure M)

The self-propelled mechanism engages by pressing the safety lever on the handle.

Self-propelled mechanism ceases when you release this bar.

Pull the safety lever back towards the handle to mow without the self-propelled mechanism.

- **Work instructions**

Mow dry grass as much as possible to save grass.

Adjust the cutting height so that the machine is not overworked.

Drive the machine at moderate speed (walking) along the belt as straight as possible. For a perfect mowing result, the strips must always overlap for a few centimetres

Do not back away.

Always work perpendicular to the slopes.

If the blades come into contact with a foreign object, immediately turn off the engine. Wait for the blades to stop turning completely and check that the unit has not been damaged.

Only resume work if the unit has not been damaged.

Turn off the appliance when taking long breaks during work and carrying the appliance.

Wait for the blades to stop turning completely.

Clean the appliance after each use as described in the chapter "Cleaning and maintenance".

6. MAINTENANCE

Carry out maintenance and cleaning work when the engine is off and the spark plug are out. Allow the tool to cool down before performing any maintenance or cleaning work. The engine elements are hot. Lack of maintenance can reduce the life of the tool, give bad result. In addition accidents and injuries can happen if the tool and blades are not well correctly maintained.

Wear gloves when handling the blades.

a. Cleaning and general maintenance tasks

- Do not tilt the unit sideways or forward. Service fluids may leak and the engine may be damaged.
- Always keep the device clean. To clean it, use a brush or cloth but no cleaning agents or acidic solutions. Do not use water to clean the engine as it may clog the fuel system.
- After mowing, remove the remains of plants stuck with a piece of wood or plastic. Clean all ventilation openings, expulsion and the area around the blades. Do not use hard or sharp objects, you could damage the device.
- Occasionally lubricate the wheels.
- Check before each use that the mower does not show visible damage such as loose, worn or damaged parts. Check that all nuts, bolts and screws are tight.
- Check that the covers and safety systems are undamaged and in place. Change them if necessary.
- To clean the blade guard, it is possible to connect a hose to the top of the housing.

b. Air filter (fig. N)

Never use the device without air filter. Dust and dirt enter the motor and damage the machine. Keep the air filter clean.

- Push the tabs and then push out the air filter cover
- Remove the air filter.
- Clean the air filter or change it for a new one.
- Reinstall the air filter in place.
Put the cover air filter and make sure that it is well installed.

c. Spark plug (fig. O)

Worn spark plug or an excessive ignition interval can decrease the engine performance.

- Remove the spark plug from the tool.
- Check the ignition interval using a template (available in the specialized stores). The

electrode gap should be 0.75 mm.

- Adjust the gap as necessary by carefully bending the spark plug ground electrode.
- Clean the spark plug with a wire brush.
- Replace the cleaned and adjusted spark plug or replace the damaged spark plugs (Torch F6RTC or LG F6RTC)

d. **Adjust the cable (fig. P)**

If the control cable for the transmission is out of sync and has too much play, you can fix it.

- Loosen the small lock nut (32a).
- Turn the adjusting nut (32b) counter clockwise: The control cable is shortened.
- Turn the adjusting nut (32b) in a clockwise direction: The cable is extended.

e. **Sharpen/change the blades**

- Remove the spark plug from its socket and inspect the blade for wear or damage.
- Always make a blunt blade sharpened by a specialized garage as it can perform an unbalance check.
- Always sharpen a blade or replace an unbalanced blade with a specialist. Incorrect mounting may cause serious. The replacement of the blade shall not be done by the operator.

Instructions for sharpening and changing the blade

WARNING: Wear gloves, turn off the engine and remove the spark plug before proceeding.

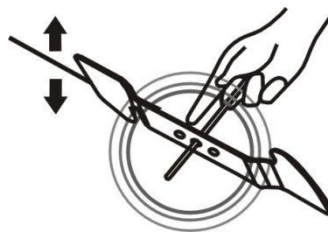

The blade is made of hardened steel. To get a clean job, sharpen the blade frequently, about every 25 hours of use. Make sure the blade is always well balanced.

Insert a small iron pin (2 or 3 mm in diameter) into the hole in the middle of the blade: it must remain horizontal. If the blade does not stay horizontal, balance it by sharpening it further on the side where it is leaning.

WARNING: Use only original spare parts. Poor quality replacement parts can cause serious damage to your mower and affect your safety. Contact our service agent to get specifications about the correct original spare parts.

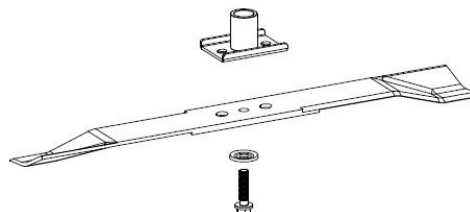

To remove the blade, loosen the screw, check the blade bracket, and replace all parts if they are worn or damaged.

To sharpen the blade, place it in a clamp and file the sharp edges evenly, checking the balance of the blade.

When reassembling the blade, make sure that the cutting edges are in the same direction as the direction of rotation of the motor. The tightening torque of the blade screw should be 3.7 kg * m / s² (37 Nm) and can be checked with a torque wrench.

f. Adjust the carburettor

The carburettor has been factory set for optimum performance. If adjustments are necessary, have them performed by a specialist.

7. STORAGE

a. General storage tips

- Clean the appliance before cleaning.
- Let the engine cool down before store the unit in a closed room.
- Use suitable and authorized containers to conserve fuel.
- Store the device in a dry place away from dust and out of the reach of children.
- To save storage space, you can fold down the upper handlebar. Loosen the quick release lever and fold down the handlebar so that the unit takes up less space. The control cables should not be stuck.
- Do not wrap the device in nylon bags as moisture and mould could appear.

b. Storage and storage for long periods without use

Failure to follow the storage instructions may lead to start-up problems due to gasoline residues in the carburettor or permanent damage.

- Empty the fuel tank into a well-ventilated place. Start the engine and let it run until it stops due to lack of fuel.
- Change the oil.
- Unscrew the spark plug.
- Pour a tablespoon of motor oil into the engine space by opening the spark plug;
- Pull the safety bar pulled slowly several times on the launcher rope to spread the oil inside the engine;
- Screw in the spark plugs thoroughly.
- Dispose of used oil and gasoline residues correctly (see "Disposal / environmental protection").

8. PROTECTION OF THE ENVIRONMENT

- Dispose the tool, its accessories and its packaging for ecological recycling.
- Carefully empty the fuel and oil tanks and take your unit to a recovery center. Plastic and metal parts can be sorted and recycled.
- Return used oil and petrol residues to the appropriate dump stations and collection points and do not discharge them into sewers or sewers.
- Address your questions about this to our service center.
- Do not dispose of cut grass in a dumpster but use it to make compost or spread it as mulch under bushes and trees.

9. TROUBLESHOOTING

PROBLEM	CAUSE	SOLUTION
Engine runs roughly	Choke in the wrong position.	Move choke lever to the RUN position.
	Dirty air filter.	Clean or replace with a new one.
	Dirty fuel valve.	Clean the fuel valve.
Engine stops suddenly	Low oil level.	Fill engine oil to proper level.
	Empty fuel tank or wrong fuel type.	See ENGINE OIL AND FUEL.
	Wrong fuel tank cap.	Replace fuel cap.
	Disconnected spark plug cap.	Secure spark plug cap.
Engine stops under heavy load	Dirty air filter.	Clean or replace with a new one.
	Engine running cold.	Allow engine warm up before operation.
Engine knocks	Engine overloaded.	Do not exceed rating load.
	Wrong fuel type.	See ENGINE OIL AND FUEL.
Engine backfires	Impure gasoline or wrong fuel type.	Drain the old fuel and refill with fresh gasoline. See ENGINE OIL AND FUEL.
	Intake valve stuck or overheated engine.	Have a qualified technician diagnose the engine.
Engine overheated	Incorrect timing.	Check engine timing.
	Low engine oil level.	Add engine oil to proper level.
	Clogged exhaust pipe.	Clean exhaust pipe.
Blade does not turn	Cooling fan blocked.	Clean cooling fan.
	Blocked with grass.	Remove the grass(see)
	Blade not installed correctly.	Check the blade and install it correctly.
Abnormal noises and vibration	Blade not installed correctly.	Check the blade and install it correctly.
	Blade damaged.	Remove the damaged blade and install a new one(See REPLACE THE BLADE).
Other	Contact an authorized service dealer for technical support.	

10. DECLARATION OF CONFORMITY



BUILDER SAS

**32, rue Aristide Bergès -Z1 31270 Cugnaux - France
Tel. +33 (0) 5.34.502.502 Fax: +33 (0) 5.34.502.503**

**Declares that the machine named below
PETROL LAWN MOWER
HTDT561ES-1**

**Serial number: 20240408536-20240408600
20240501740-20240501799**

Complies with the following European Directives:

Machinery Directive 2006/42/EC

EMC Directive 2014/30/EU

Emission directive (EU) 2016/1628 & 2017/656/EU

Other applicable guidelines:

Noise Directive 2000/14/EC Annex VI and 2005/88/EC

Guaranteed Sound Power Level	98 dB(A)
Measured sound power level L _{wA}	91,86 dB (A); K =4,53 dB

Notified body

TÜV Rheinland LGA Products GmbH - Tillystraße 2 - 90431 Nürnberg

Notified by Zentralstelle der Länder für Sicherheitstechnik (ZLS).

Notified under No. **0197** to the EC Commission.

Applicable harmonized standards:

EN ISO 5395-1:2013+A1:2018

EN ISO 5395-2:2013+A1:2016+A2:2017

EN ISO 14982: 2009

Cugnaux, 22/02/2024

Philippe MARIE / CEO

Responsible of technical file: M. Olivier Patriarca

11. WARRANTY

HYUNDAI

WARRANTY

The manufacturer guarantees the product against defects in material and workmanship for a period of 2 years from the date of the original purchase. The warranty only applies if the product is for household use. The warranty does not cover breakdowns due to normal wear and tear.

The manufacturer agrees to replace parts identified as defective by the designated distributor. The manufacturer does not accept responsibility for the replacement of the machine, in whole or in part, and/or ensuing damage.

The warranty does not cover breakdowns due to:

- insufficient maintenance.
- abnormal assembly, adjustment or operations of the product.
- parts subject to normal wear and tear.

The warranty does not extend to:

- shipping and packaging costs.
- using the tool for a purpose other than that for which it was designed.
- the use and maintenance of the machine done in a manner not described in the user manual.

Due to our policy of continuous product improvement, we reserve the right to alter or change specifications without notice. Consequently, the product may be different from the information contained therein, but a modification will be undertaken without notice if it is recognized as an improvement of the preceding characteristic.

READ THE MANUAL CAREFULLY BEFORE USING THE MACHINE.

When ordering spare parts, please indicate the part number or code, you can find this in the spare parts list in this manual. Keep the purchase receipt; without it, the warranty is invalid. To help you with your product, we invite you to contact us by phone or via our website:

- **+33 (0)9.70.75.30.30**
- **<https://services.swap-europe.com/contact>**

You must create a "ticket" via the web platform.

- Register or create your account.
- Indicate the reference of the tool.
- Choose the subject of your request.
- Describe your problem.
- Attach these files: invoice or sales receipt, photo of the identification plate (serial number), photo of the part you need (for example: pins on the transformer plug which are broken).



12. PRODUCT FAILURE

WHAT TO DO IF MY MACHINE BREAKS DOWN?

If you bought your product in a store:

- a) Empty the fuel tank if your product has one.
- b) Make sure that your machine is complete with all accessories supplied, and clean! If this is not the case, the repairer will refuse the machine.

Go to the store with the complete machine and with the receipt or invoice.

If you bought your product on a website:

- a) Empty the fuel tank if your product has one..
- b) Make sure that your machine is complete with all accessories supplied, and clean! If this is not the case, the repairer will refuse the machine.
- c) Create a SWAP-Europe service ticket on the site: <https://services.swap-europe.com> When making the request on SWAP-Europe, you must attach the invoice and the photo of the nameplate (serial number).
- d) Contact the repair station to make sure it is available before dropping off the machine.

Go to the repair station with the complete machine packed, accompanied by the purchase invoice and the station support sheet downloadable after the service request is completed on the SWAP-Europe site

For machines with engine failure from manufacturers BRIGGS & STRATTON, HONDA and RATO, please refer to the following instructions.

Repairs will be done by approved engine manufacturers of these manufacturers, see their site:

- <http://www.briggsandstratton.com/eu/fr>
- <http://www.honda-engines-eu.com/fr/service-network-page;jsessionid=5EE8456CF39CD572AA2AEEDFD290CDAE>
- <https://www.rato-europe.com/it/service-network>

Please keep your original packaging to allow for after-sales service returns or pack your machine with a similar cardboard box of the same dimensions.

For any question concerning our after-sales service you can make a request on our website <https://services.swap-europe.com>

Our hotline remains available at +33 (9) 70 75 30 30.



13. WARRANTY EXCLUSIONS

THE WARRANTY DOES NOT COVER:

- Start-up and setting up of the product.
- Damage resulting from normal wear and tear of the product.
- Damage resulting from improper use of the product.
- Damage resulting from assembly or start-up not in accordance with the user manual.
- Breakdowns related to carburetion beyond 90 days and fouling of carburetors.
- Periodic and standard maintenance events.
- Actions of modification and dismantling that directly void the warranty.
- Products whose original authentication marking (brand, serial number) has been degraded, altered or withdrawn.
- Replacement of consumables.
- The use of non-original parts.
- Breakage of parts following impacts or projections.
- Accessories breakdowns.
- Defects and their consequences linked to any external cause.
- Loss of components and loss due to insufficient screwing.
- Cutting components and any damage related to the loosening of parts.
- Overload or overheating.
- Poor power supply quality: faulty voltage, voltage error, etc.
- Damages resulting from the deprivation of enjoyment of the product during the time necessary for repairs and more generally the costs related to the immobilization of the product.
- The costs of a second opinion established by a third party following an estimate by a SWAP-Europe repair station
- The use of a product which would show a defect or a breakage which was not the subject of an immediate report and/or repair with the services of SWAP-Europe.
- Deterioration linked to transport and storage*.
- Launchers beyond 90 days.
- Oil, petrol, grease.
- Damages related to the use of non-compliant fuels or lubricants.

* In accordance with transport legislation, damage related to transport must be declared to carriers within 48 hours maximum after observation by registered letter with acknowledgement of receipt.

This document is a supplement to your notice, a non-exhaustive list.

Attention: all orders must be checked in the presence of the delivery person. In case of refusal by the delivery person, it you must simply refuse the delivery and notify your refusal.

Reminder: the reserves do not exclude the notification by registered letter with acknowledgement within 72 hours.

Information: Thermal devices must be wintered each season (service available on the SWAP-Europe site). Batteries must be charged before being stored.

HYUNDAI
POWER PRODUCTS



For inquiries, please contact:

BUILDER SAS

32 rue Aristide Bergès - Z.I. du Casque - 31270 Cugnaux - France

Tél.: +33(0)5.34.502.502 Fax.: +33(0)5.34.502.503

<http://www.hyundaipower-fr.com/>

Fabriqué en République Populaire de Chine(PRC)